

TOSHIBA CCD LINEAR IMAGE SENSOR CCD(Charge Coupled Device)

TCD1201D

The TCD1201D is a high sensitive and low dark current 2048-elements linear image sensor. The sensor can be used for POS handscanner.

The device is operated by only 5V power supply, and mounted in 22-pin cerdip package with hermetic sealed optical glass window.

FEATURES

- Number of Image Sensing Elements : 2048
- Image Sensing Element Size : 14 μ m by 200 μ m on 14 μ m centers
- Photo Sensing Region : High sensitive and low dark current pn photodiode
- Clock : 2 phase (5V)
- Package : 22 pin cerdip

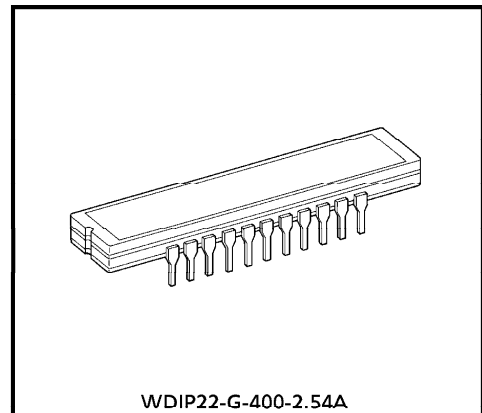

Weight : 4.4g (Typ.)

MAXIMUM RATINGS (Note 1)

CHARACTERISTIC	SYMBOL	RATING	UNIT
Clock Pulse Voltage	V_{ϕ}	- 0.3~8	V
Shift Pulse Voltage	V_{SH}		V
Reset, Boost Pulse Voltage	V_{RS}, V_{BT}		V
Power Supply Voltage	V_{OD}		V
Operating Temperature	T_{opr}	- 25~60	°C
Storage Temperature	T_{stg}	- 40~100	°C

(Note 1) All voltage are with respect to SS terminals (Ground).

PIN CONNECTIONS

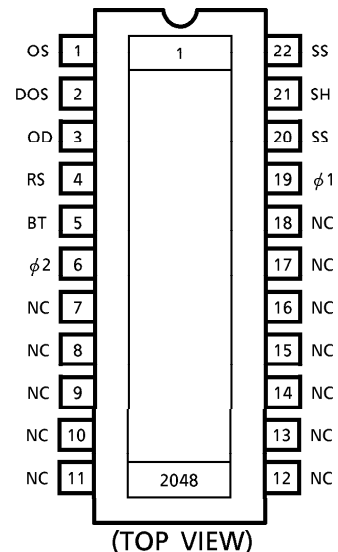

961001EBA2

● TOSHIBA is continually working to improve the quality and the reliability of its products. Nevertheless, semiconductor devices in general can malfunction or fail due to their inherent electrical sensitivity and vulnerability to physical stress. It is the responsibility of the buyer, when utilizing TOSHIBA products, to observe standards of safety, and to avoid situations in which a malfunction or failure of a TOSHIBA product could cause loss of human life, bodily injury or damage to property. In developing your designs, please ensure that TOSHIBA products are used within specified operating ranges as set forth in the most recent products specifications. Also, please keep in mind the precautions and conditions set forth in the TOSHIBA Semiconductor Reliability Handbook.

CIRCUIT DIAGRAM

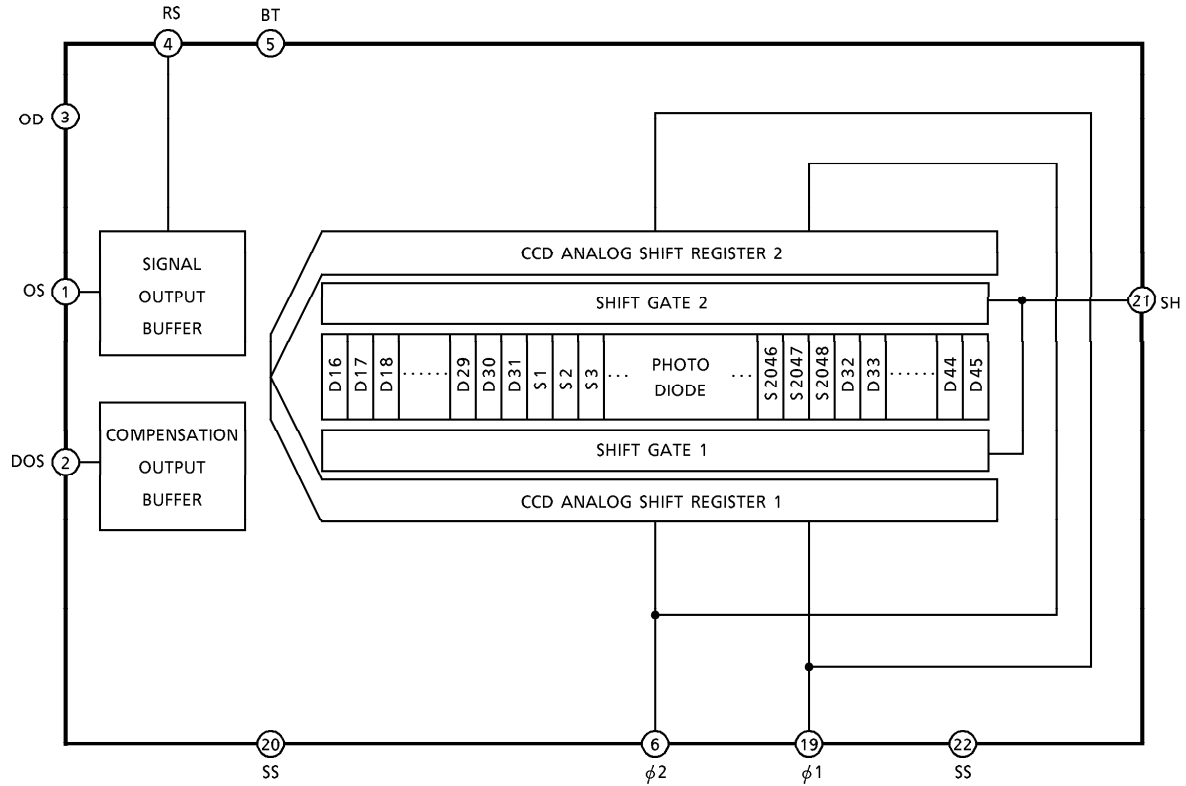

PIN NAMES

$\phi 1$	Clock (Phase 1)
$\phi 2$	Clock (Phase 2)
BT	Boost Pulse
SH	Shift Gate
RS	Reset Gate
OS	Signal Output
DOS	Compensation Output
OD	Power
SS	Ground
NC	Non Connection

961001EBA2'

● The products described in this document are subject to foreign exchange and foreign trade control laws.
 ● The information contained herein is presented only as a guide for the applications of our products. No responsibility is assumed by TOSHIBA CORPORATION for any infringements of intellectual property or other rights of the third parties which may result from its use. No license is granted by implication or otherwise under any intellectual property or other rights of TOSHIBA CORPORATION or others.
 ● The information contained herein is subject to change without notice.

OPTICAL / ELECTRICAL CHARACTERISTICS

(Ta = 25°C, VOD = 12V, Vφ = VSH = VRS = VBT = 5V (PULSE), fφ = 0.5MHz, fRS = 1MHz, Load Resistance = 100kΩ, tINT (Integration Time) = 10ms, Light Source = Daylight Fluorescent Lamp)

CHARACTERISTIC	SYMBOL	MIN.	TYP.	MAX.	UNIT	NOTE
Sensitivity	R	64	80	96	V / lx·s	(Note 2)
Photo Response Non Uniformity	PRNU	—	—	10	%	(Note 3)
Saturation Output Voltage	VSAT	0.6	0.8	—	V	(Note 4)
Saturation Exposure	SE	0.006	0.01	—	lx·s	(Note 5)
Dark Signal Voltage	VMDK	—	2	5	mV	(Note 6)
Analog Current Dissipation	I _{OD}	—	3	5	mA	V _{OD} = 5V
Total Transfer Efficiency	TTE	92	95	—	%	
Output Impedance	Z _O	—	0.5	1	kΩ	
Dynamic Range	DR	—	400	—		(Note 7)
DC Signal Output Voltage	V _{OS}	1.5	3.0	4.5	V	(Note 8)
DC Compensation Output Voltage	V _{DOS}	1.5	3.0	4.5	V	(Note 8)
DC Mismatch Voltage	V _{OS} -V _{DOS}	—	—	100	mV	

(Note 2) Sensitivity for LED (660nm) is 600V / lx·s (Typ.)

(Note 3) Measured at 50% of SE (Typ.)

$$\text{Definition of PRNU : PRNU} = \frac{\Delta x}{\bar{x}} \times 100 (\%)$$

Where \bar{x} is average of total signal outputs and Δx is the maximum deviation from \bar{x} under uniform illumination.

(Note 4) V_{SAT} is defined as minimum saturation output voltage of all effective pixels.

$$\text{(Note 5) Definition of SE : SE} = \frac{V_{SAT}}{R} \text{ (lx·s)}$$

(Note 6) V_{MDK} is defined as maximum dark signal voltage of all effective pixels.

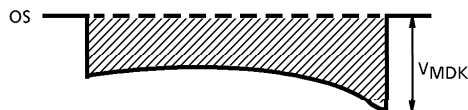

(Note 7) Definition of DR : $DR = \frac{V_{SAT}}{V_{MDK}}$

V_{MDK} is proportional to t_{INT} (Integration Time).
So the shorter t_{INT} condition makes wider DR value.

(Note 8) DC signal output voltage and DC compensation output voltage are defined as follows:

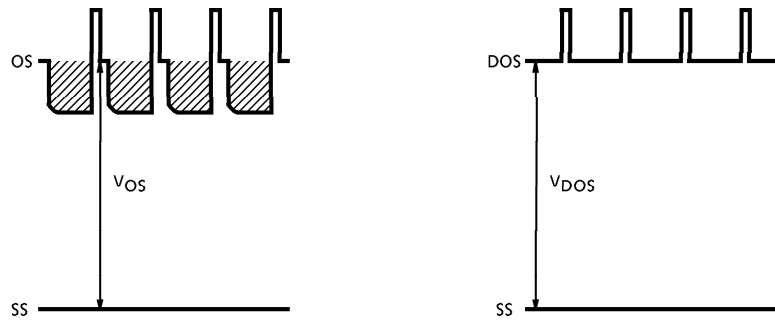

OPERATING CONDITION

CHARACTERISTIC		SYMBOL	MIN.	TYP.	MAX.	UNIT
Clock Pulse Voltage	"H" Level	V_{ϕ}	4.5	5.0	5.5	V
	"L" Level		0	0.2	0.5	
Shift Pulse Voltage	"H" Level	V_{SH}	4.5	5.0	5.5	V
	"L" Level		0	0.2	0.5	
Reset Boost Pulse Voltage	"H" Level	V_{RS}	4.5	5.0	5.5	V
	"L" Level	V_{BT}	0	0.2	0.5	
Power Supply Voltage		V_{OD}	4.5	5.0	5.5	V

CLOCK CHARACTERISTICS (Ta = 25°C)

CHARACTERISTIC	SYMBOL	MIN.	TYP.	MAX.	UNIT
Clock Pulse Frequency	f_{ϕ}	0.01	0.5	1.0	MHz
Reset Pulse Frequency	f_{RS}	0.02	1.0	2.0	MHz
Clock Capacitance	$C_{\phi A}$	—	400	500	pF
BT Gate Capacitance	C_{BT}	—	10	25	pF
Shift Gate Capacitance	C_{SH}	—	200	250	pF
Reset Gate Capacitance	C_{RS}	—	10	25	pF

TIMING CHART

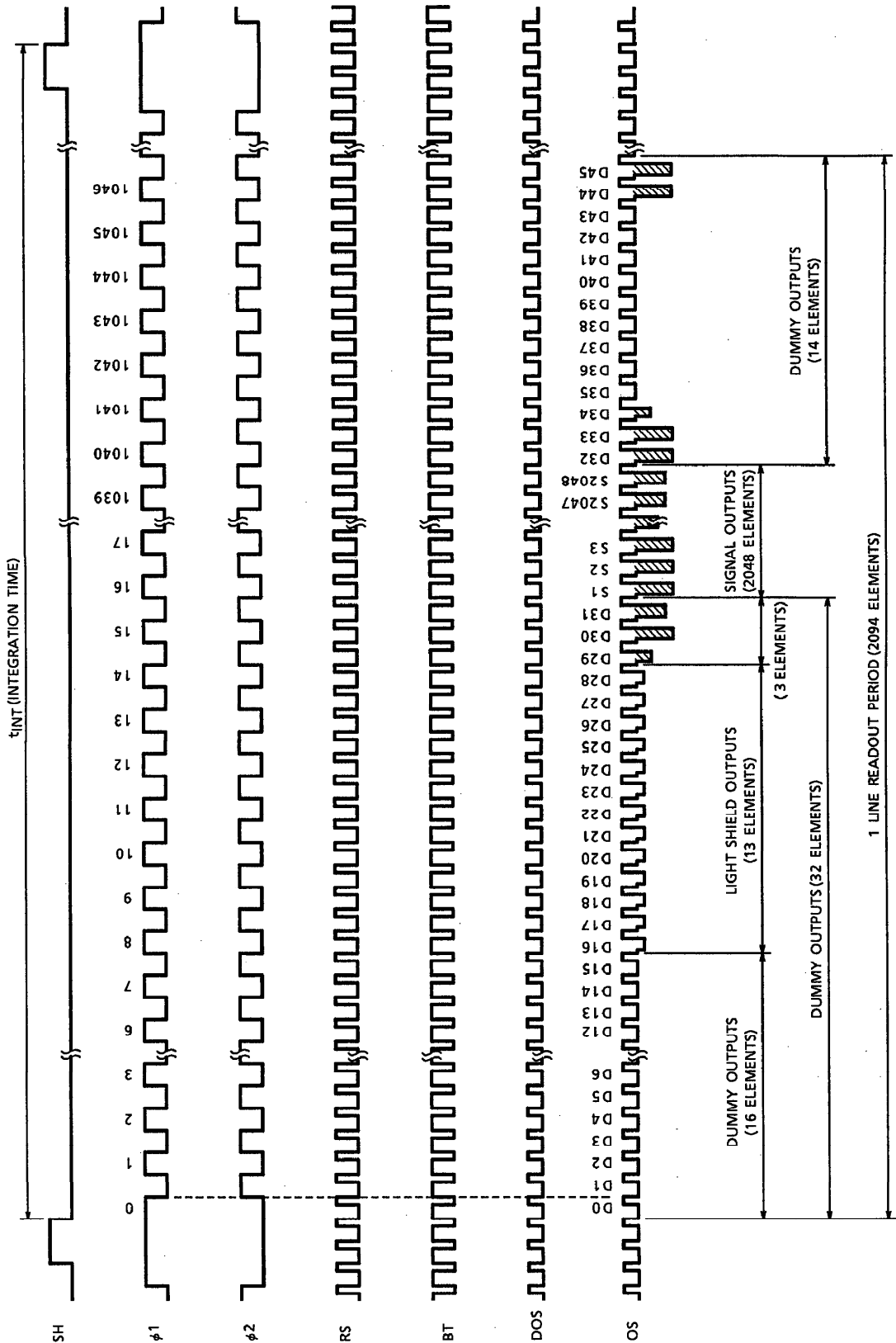

TIMING REQUIREMENTS

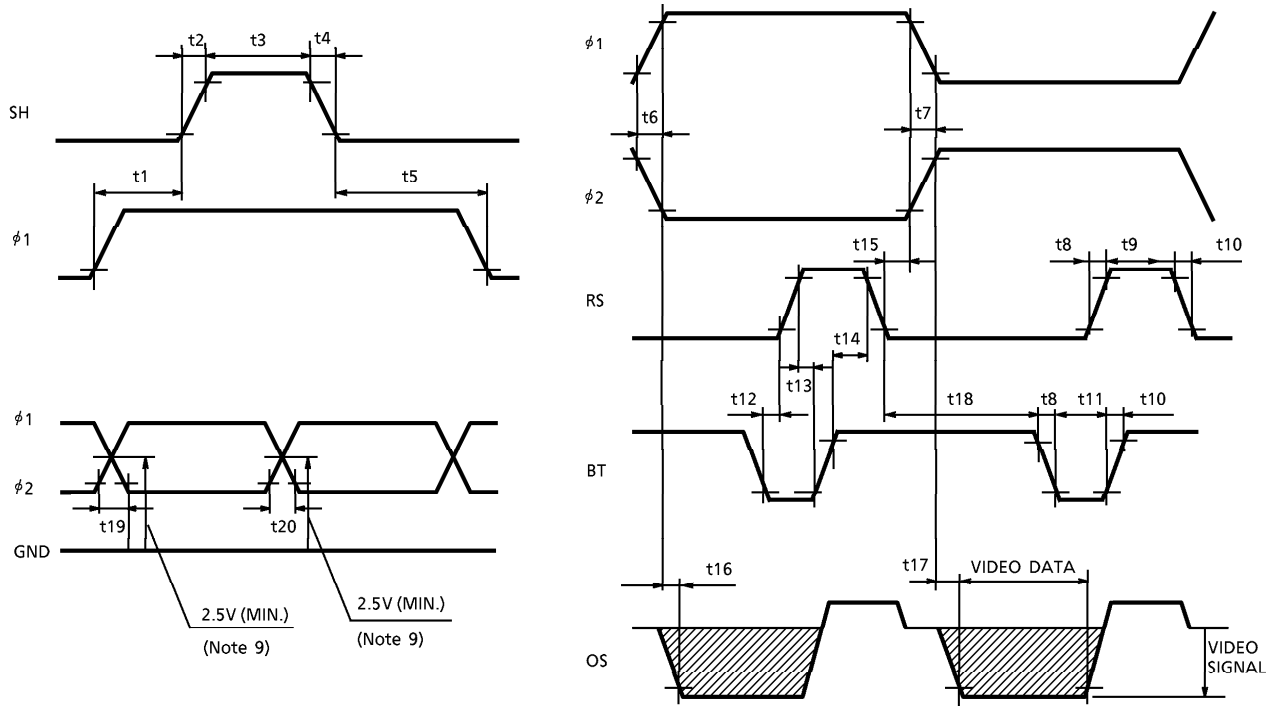

CHARACTERISTIC	SYMBOL	MIN.	TYP.	MAX.	UNIT
Pulse Timing of SH and $\phi 1, \phi 2$	t1	0	100	—	ns
	t5	2000	3000	—	ns
SH Pulse Rise, and Fall Time	t2, t4	0	50	—	ns
SH Pulse Width	t3	1000	2000	—	ns
$\phi 1, \phi 2$ Pulse Rise and Fall Time	t6, t7	0	60	—	ns
RS, BT Pulse Rise and Fall Time	t8, t10	0	20	—	ns
RS Pulse Width	t9	60	250	—	ns
BT Pulse Width	t11	70	250	—	ns
Pulse Timing of RS and BT	t12	50	100	—	ns
	t13	20	—	—	ns
	t14	40	—	—	ns
	t18	200	—	—	ns
Pulse Timing of $\phi 1, \phi 2, RS$	t15	20	—	—	ns
Video Data Delay Time	t16, t17	—	80	—	ns

(Note 9) If $\phi 1$ & $\phi 2$ pulse cross point could't be kept over 2.5V, it should be 1.5V and t19 and t20 should be 60ns.

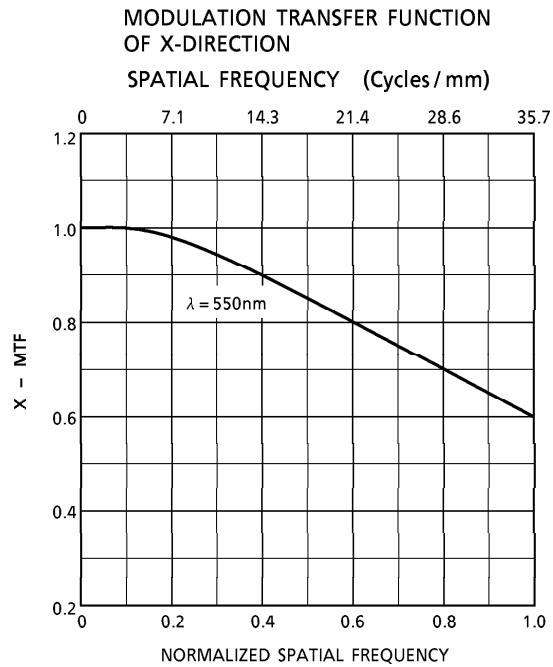
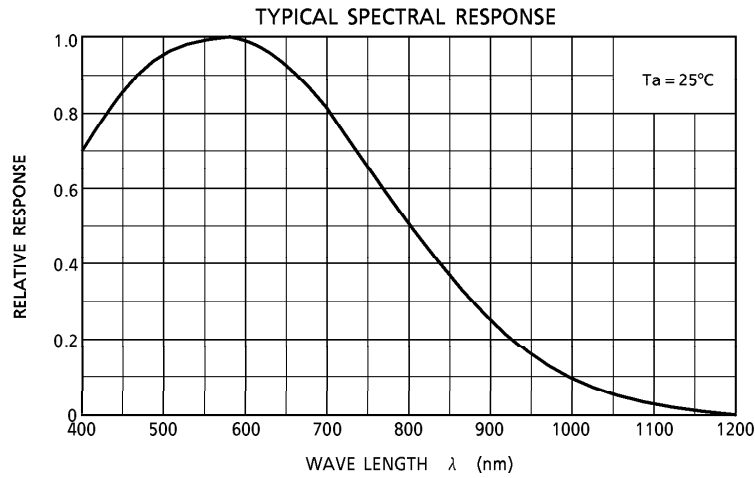

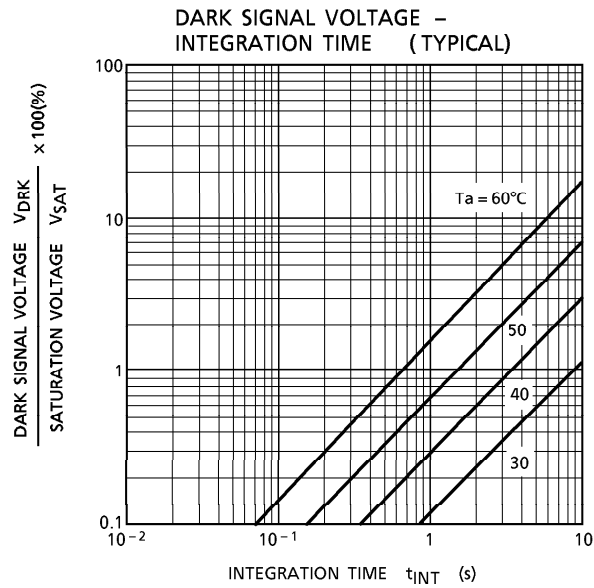
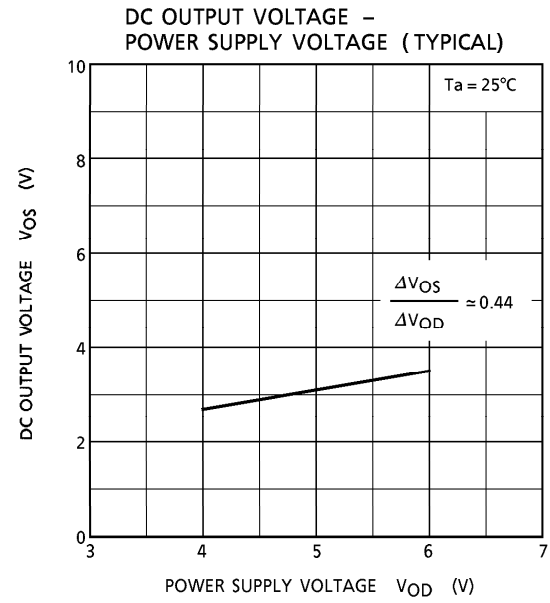
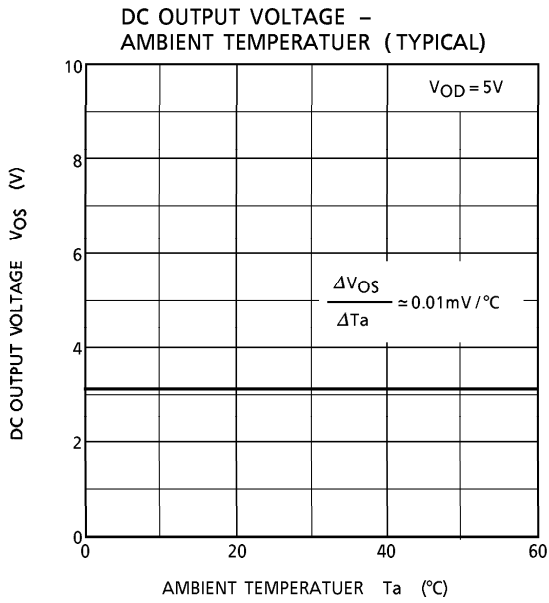

TYPICAL DRIVE CIRCUIT

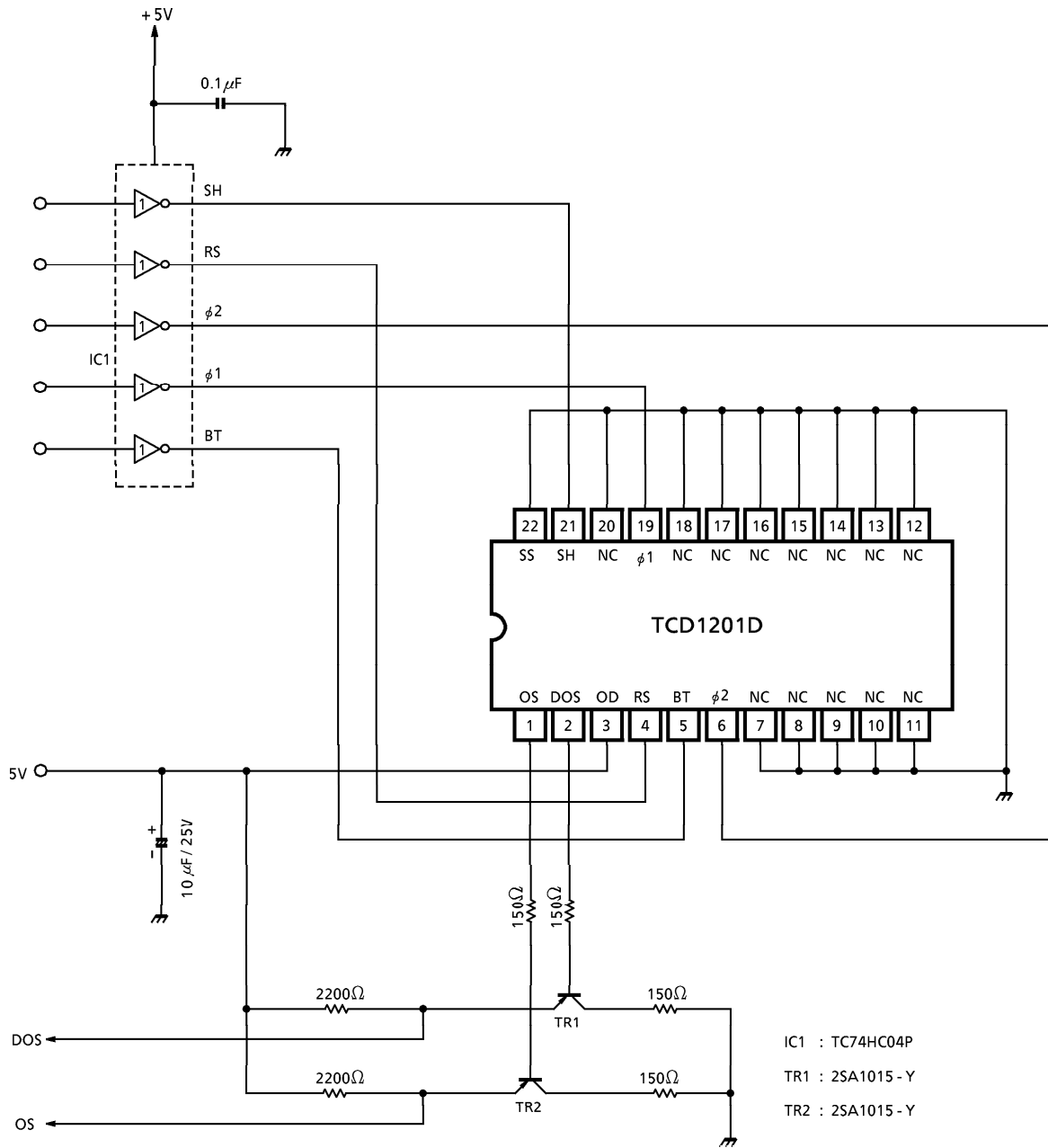

CAUTION**1. Window Glass**

The dust and stain on the glass window of the package degrade optical performance of CCD sensor.

Keep the glass window clean by saturating a cotton swab in alcohol and lightly wiping the surface, and allow the glass to dry, by blowing with filtered dry N₂.

Care should be taken to avoid mechanical or thermal shock because the glass window is easily to damage.

2. Electrostatic Breakdown

Store in shorting clip or in conductive foam to avoid electrostatic breakdown.

3. Incident Light

CCD sensor is sensitive to infrared light.

Note that infrared light component degrades resolution and PRNU of CCD sensor.

4. Lead Frame Forming

Since this package is not stout against mechanical stress, you should not reform the lead frame.

We recommend to use a IC-inserter when you assemble to PCB.

OUTLINE DRAWING

WDIP22-G-400-2.54A (D)

Unit : mm

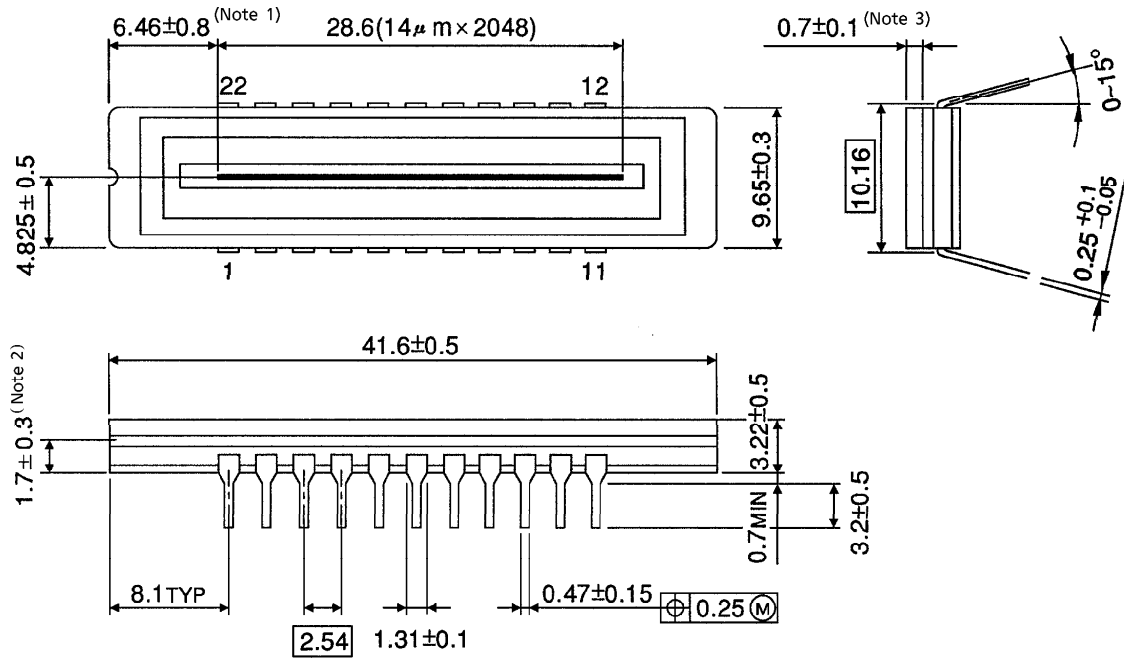

- (Note 1) No. 1 SENSOR ELEMENT (S1) TO EDGE OF PACKAGE.
- (Note 2) TOP OF CHIP TO BOTTOM OF PACKAGE.
- (Note 3) GLASS THICKNES (n = 1.5)

Weight : 4.4g (Typ.)